



Laird Connectivity's OC35506P is a Low PIM omnidirectional, collinear antenna especially designed to complement interior or exterior mounted wireless networks operating over the CBRS band 3550-3700 MHz. An integrated RF connector is embedded in the antenna base cap for direct AP mounting. It comes complete with mast mounting hardware and includes a UV-stable radome enclosure that provides years of use without degradation to either mechanical properties or aesthetics.

FEATURES AND BENEFITS

- Applicable for CBRS solutions
- Indoor/outdoor usage
- Weatherproof UV stable radome
- Direct to radio or mast/pole mounting
- Mast mounting hardware included
- Low PIM rated with an IP67 Ingress Protection rating.
- Conformance to RoHS

ELECTRICAL SPECIFICATIONS	
Antenna Model	OC35506P
Number of Ports	1
Operating Frequency (MHz)	3550-3700
VSWR, Avg.	1.4:1
VSWR, Max.	1.5:1
Peak Gain, Avg. (dBi)	6.1
Peak Gain, Max. (dBi)	6.8
Passive Intermodulation @ 2 x 10 Watt (dBc)	< -150
Azimuth 3 dB Beamwidth	360°
Nominal Impedance (Ohms)	50
Polarization	Linear, Vertical
Max Power/port- Ambient 25°C (W)	360°

MECHANICAL SPECIFICATIONS	
Dimensions – diameter x height – mm (inches)	25.4 x 257 (1.0 x 10.0)
Weight – kg (lbs.)	0.12 (0.27)
Radome Material	PC, UL94 V-0, UV Stable

ENVIRONMENTAL SPECIFICATIONS	
Operating Environment (Indoor or Outdoor)	Indoor and Outdoor
Operating Temperature – °C (°F)	-30 to +70°C (-22 to +158°F)
Storage Temperature – °C (°F)	-40 to +85°C (-40 to +185°F)
Wind Rating (*) Operational, kph (mph)	193 (120)
Wind Rating (*) Survival, kph (mph)	219 (136)
Ingress Protection	IP67
Material Substance Compliance	RoHS Compliant

* Based on static load by wind at maximum velocity

CONFIGURATION

PART NUMBER	CONNECTOR
OC35506P-FNF	Type N female

PACKAGING INFORMATION

PACKAGED DIMENSIONS	CARTON	MASTER CARTON	AIR PALLET	OCEAN PALLET
Number of Antennas	1	77	462	616
Height- cm (in.)	3.4 (1.3)	42.2 (16.6)	141 (55.5)	183 (72.1)
Length- cm (in.)	43.5 (17.1)	74.4 (29.3)	120 (47.3)	120 (47.3)
Width- cm (in.)	10.2 (4.02)	44.7 (17.6)	80 (32)	80 (32)
Shipping Weight - kg (lb.)	0.64 (1.4)	50.2 (111)	313 (691)	414 (912)

MECHANICAL DRAWING

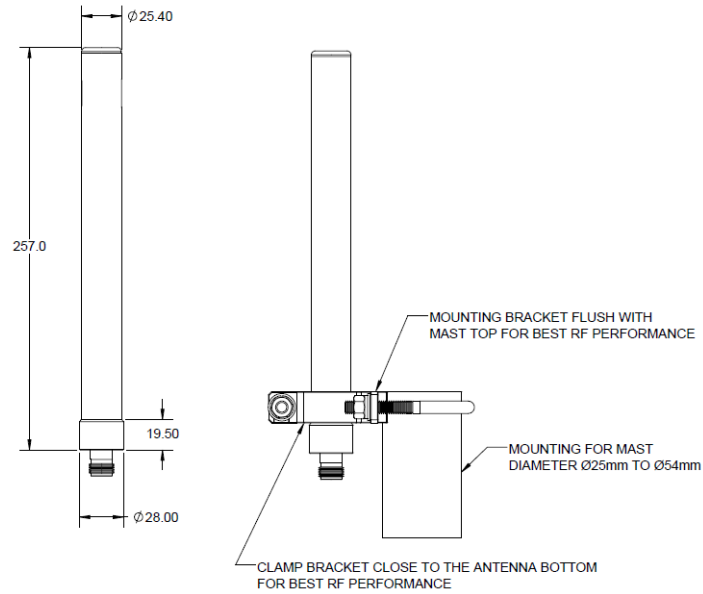

RADIATION PATTERNS

3550 MHz

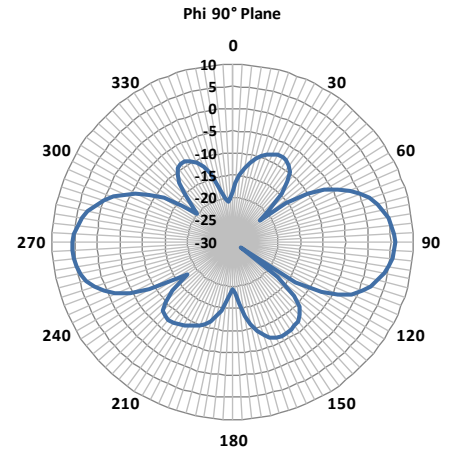
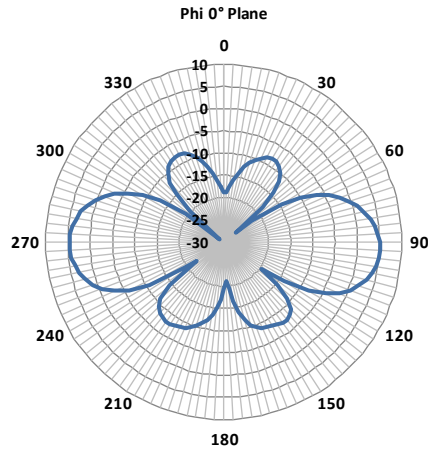
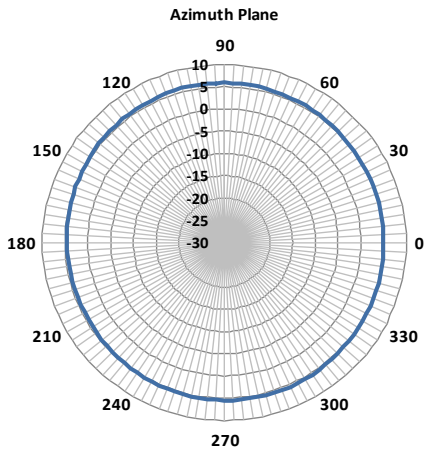

3600 MHz

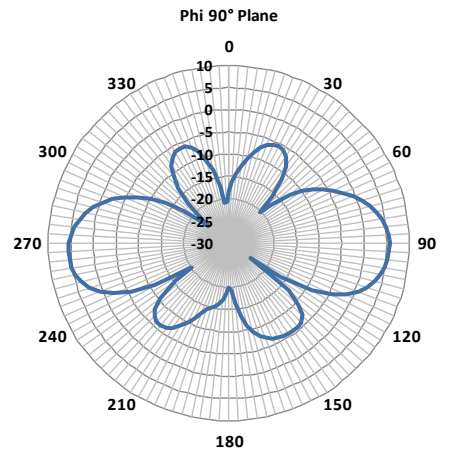
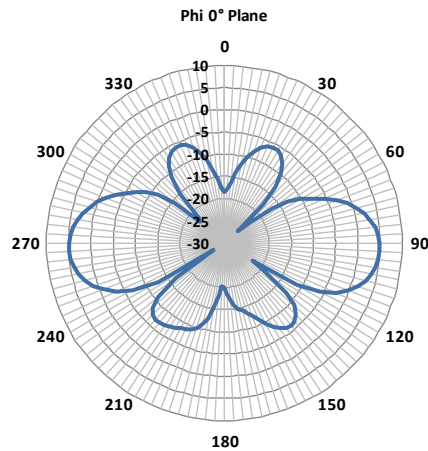
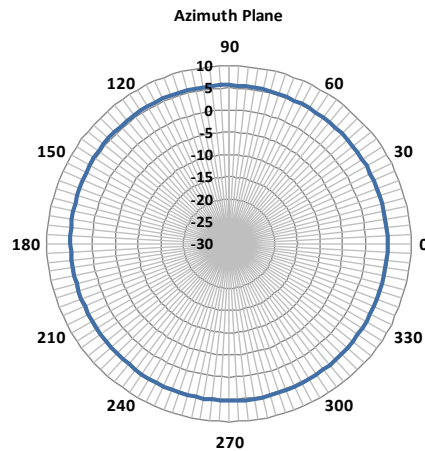

RADIATION PATTERNS

3650 MHz

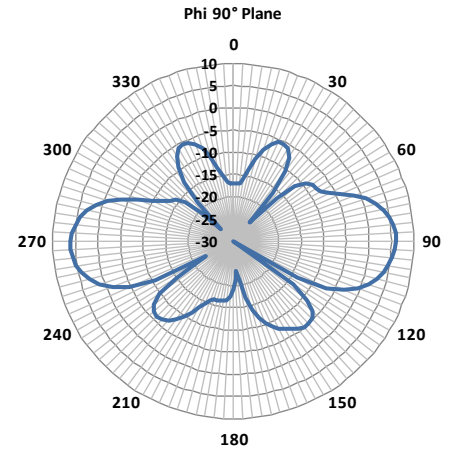
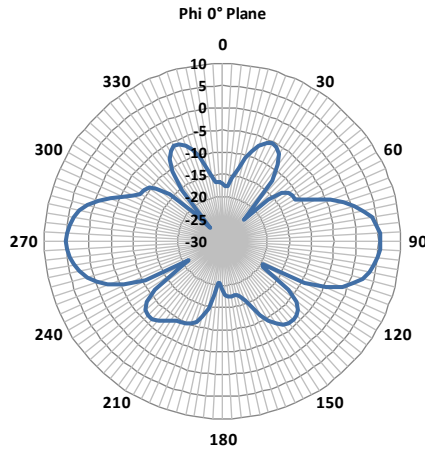
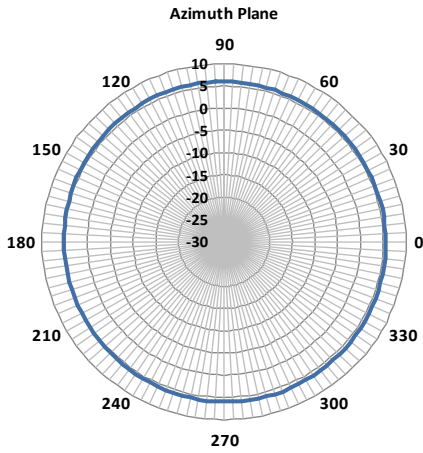

3700 MHz

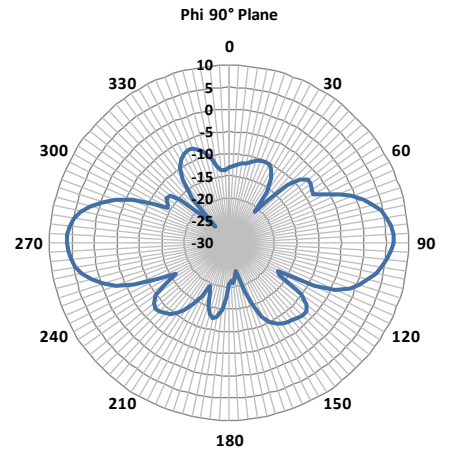
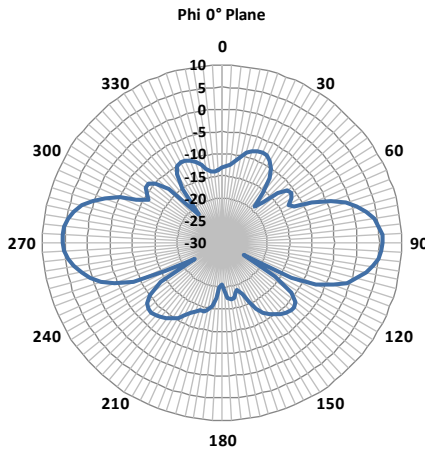
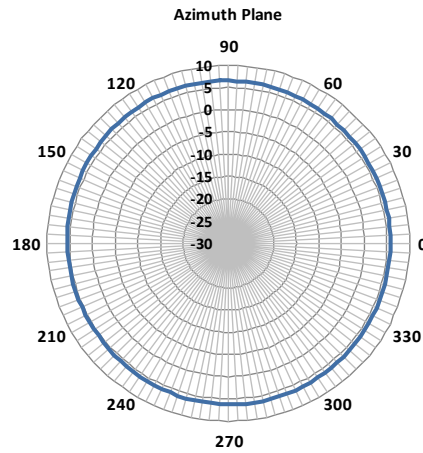

Laird warrants to the original end user customer of its products that its products are free from defects in material and workmanship. Subject to conditions and limitations Laird will, at its option, either repair or replace any part of its products that prove defective because of improper workmanship or materials. This limited warranty is in force for the useful lifetime of the original end product into which the Laird product is installed. Useful lifetime of the original end product may vary but is not to exceed five (5) years from the original date of the end product purchase.

Any information furnished by Laird Inc. and its agents is believed to be accurate and reliable. All specifications are subject to change without notice. Responsibility for the use and application of Laird materials rests with the end user, since Laird and its agents cannot be aware of all potential uses. Laird makes no warranties as to the fitness, merchantability or suitability of any Laird materials or products for any specific or general uses. Laird shall not be liable for incidental or consequential damages of any kind. All Laird products are sold pursuant to the Laird Terms and Conditions of sale in effect from time to time, a copy of which will be furnished upon request.

© Copyright 2019 Laird Inc. All Rights Reserved. Laird, Laird Technologies, the Laird Logo, and other marks are trademarks or registered trademarks of Laird Inc. or an affiliate company thereof. Other product or service names may be the property of third parties. Nothing herein provides a license under any Laird or any third party intellectual property rights.

sales@lairdconnect.com
support@lairdconnect.com
www.lairdconnect.com

